



# Motorcycles Accessories



# Catalog

Edition 2018

# Fig. Z01.01 Protectors

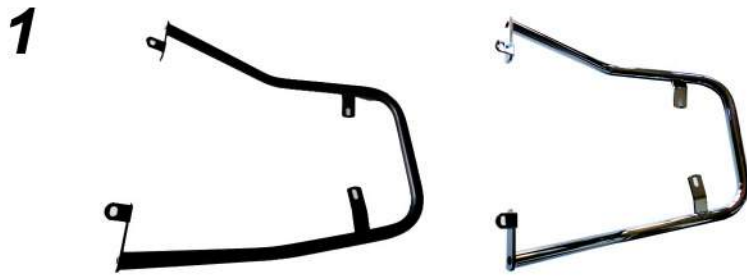

# Fig. Z01.02 Protectors



1



2



3



4



4





# Fig. Z02.01 Luggage racks

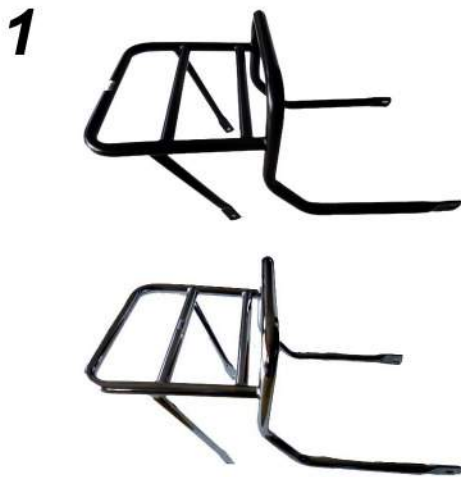

# Fig. Z02.02 Luggage racks



1



2



3



4





# Fig. Z02.03 Luggage racks



1



2



3



4



# Fig. Z03.01 Luggage systems



## System Baraholka (parts)

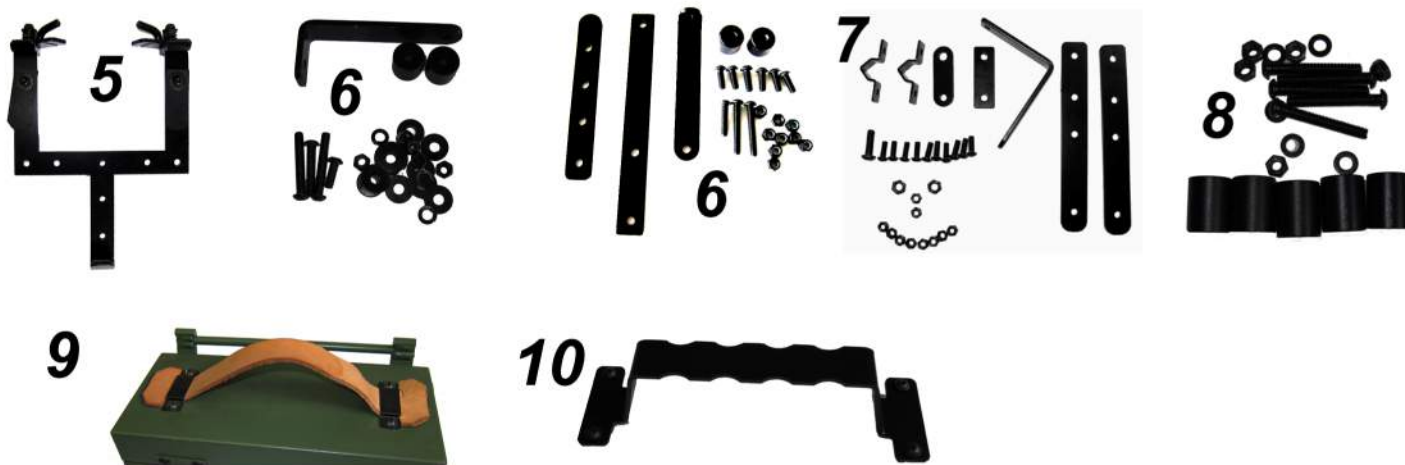

Boxes are delivered without logo, please choose one of these: suitable for Baraholka and first aid boxes (attached with screws)

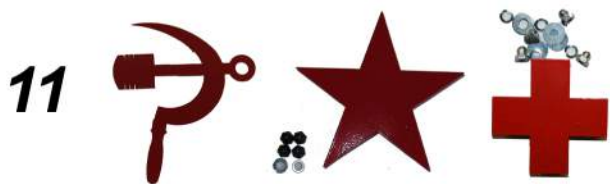



## **Fig. Z03.02 Luggage systems**



### **System Baraholka (mounting)**



***Retro with luggage rack =  
IDE40 + IDE48 + IDE49***

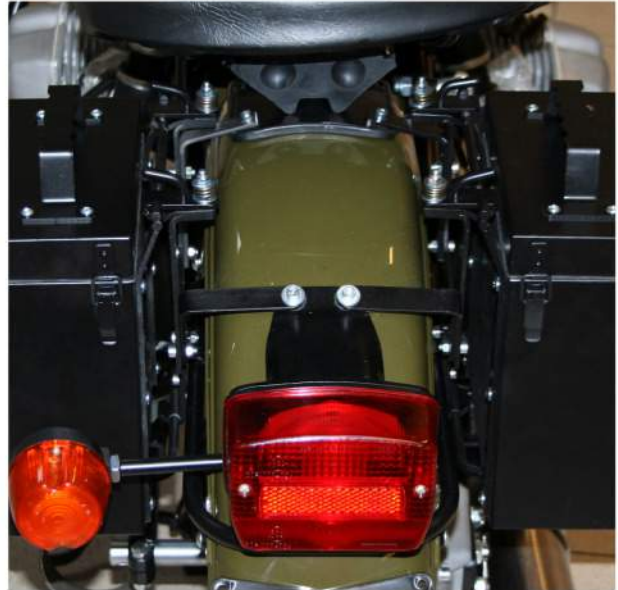

***Retro without rack =  
IDE40 + IDE48***



***Ranger, Tourist, Sportsman = IDE40 + IDE47***





**Fig. Z03.03 Luggage systems**



# Fig. Z03.04 Luggage systems





# Fig. Z04.01 Seats



# Fig. Z04.02 Seats



**13 = 10+11+12**



# Fig. Z05.01 Comfort



**Fig. Z06.01 Complete wheels**

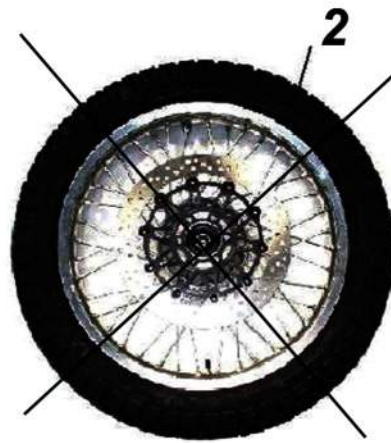
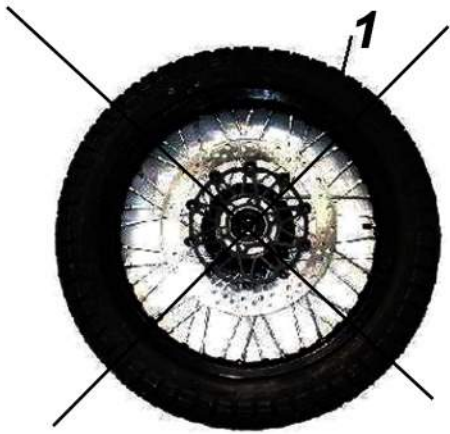

**Disc  
brake**

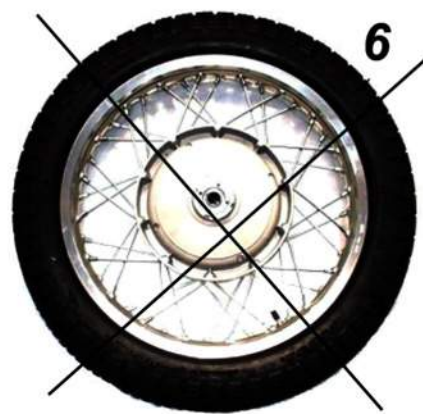
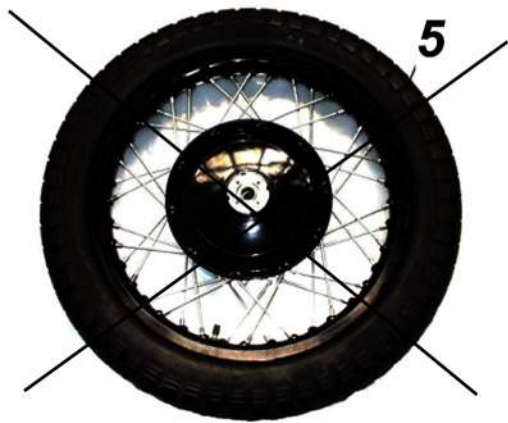

**Drum  
brake**

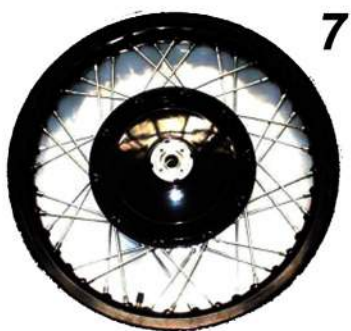



# Fig. Z06.02 Wheels, Rims, Tyres



*Enduro K37 19"*  
*Enduro K37 19" M+S*  
*Enduro K37 19" M+S / Spike*



*Enduro K67 18"*  
*Enduro K67 18" / Spike*



*Road Avon 18"*



*Road Avon 19"*



*Road Uralshina 19"*



*Road K34 19"*



*Road K36 18"*



*Road K28 18"*

# Fig. Z06.03 Wheels, Rims, Tyres



*Tube 18" / Tube 19"*



*Rim band 18/19"  
Felgenband 18/19"*



**9**





# Fig. Z07.01 Windshields



1



2



3



# Fig. Z07.02 Windshields



1



2



3



4

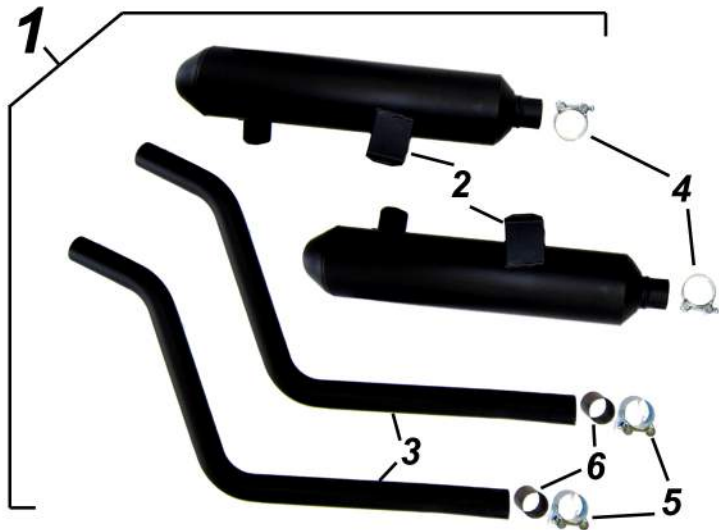



**Fig. Z08.01 Exhaust systems**



# Fig. Z08.02. Exhaust Systems





# Fig. Z09.01 Tuningparts, upgrade



## Ducati ignition

1



2



3



4



5



# Fig. Z09.02 Tuningparts, upgrades

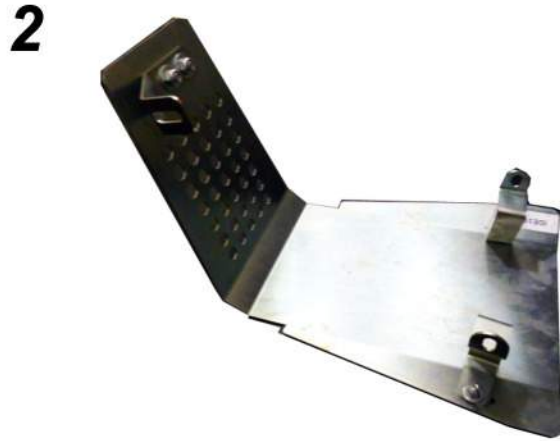

## Adapter KP33

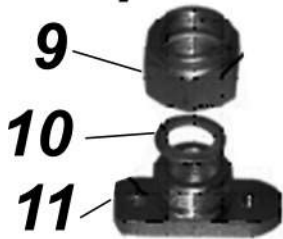



# Fig. Z09.03 Tuningparts, upgrades



1



2



3



4



5



6

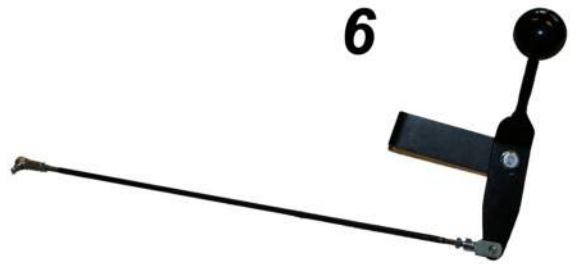

7



11



10

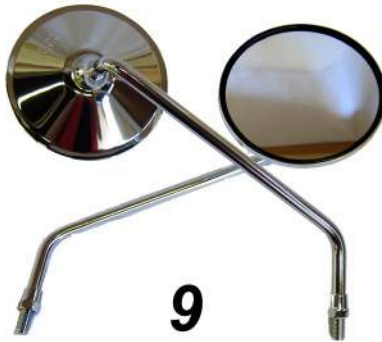

9



8



12

**Fig. Z09.04 Tuningparts, upgrades**





# Fig. Z10.01 Lights



1



2



9



4



3



10

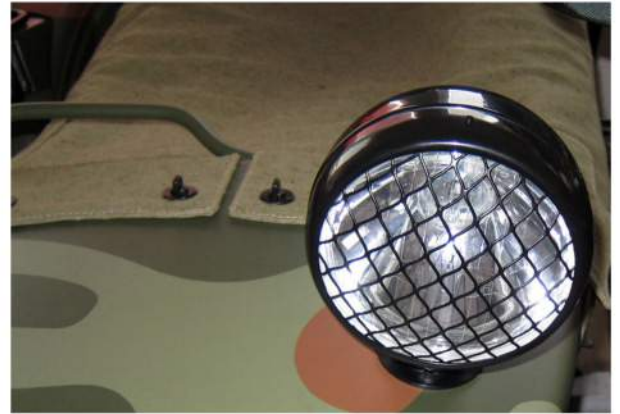

5



6



7



8



# Fig. Z10.02 Lights



1



2



3



4



5





# Fig. Z11.01 Bike protection



1



2



3



4



5

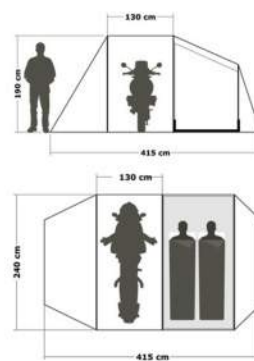

6

**Aerospace Protection**

**Anti Corrosion Fogging Oil**  
Protects All Metals & Chrome  
Treats Electrical Connectors  
Superior Moisture Barrier  
Neutralizes Road Salt  
Keeps Mud & Bugs from Sticking!

**Kills Corrosion on Contact!**

**ACF-50**  
ANTI-CORROSION FORMULA

**PROTECTS • PENETRATES • LUBRICATES**  
Motorcycles • Dirtbikes • Scooters • ATVs / UTVs

# Fig. Z12.01 Apparel



**8**



**11**



**12**





# Fig. Z12.02 Apparel



# Fig. Z12.03 Apparel



1



2



3





# Fig. Z13.01 Collectibles





# Fig. Z13.02 Collectibles

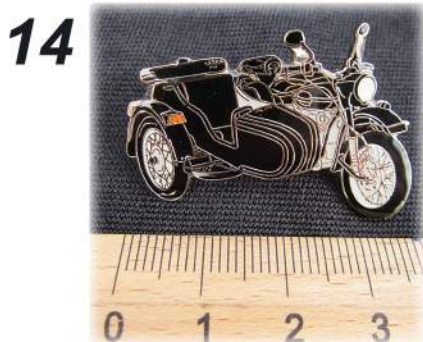
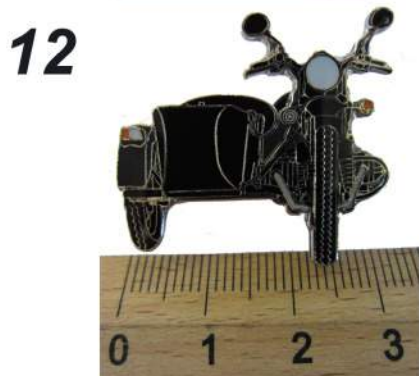
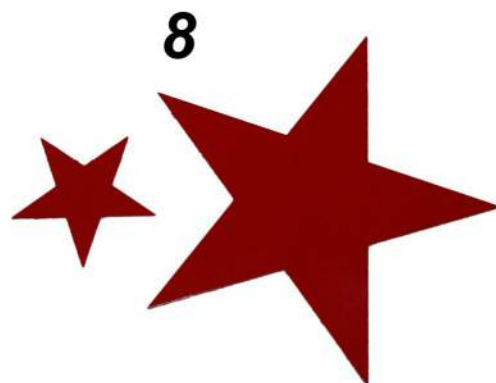



# Fig. Z14.01 Trailer

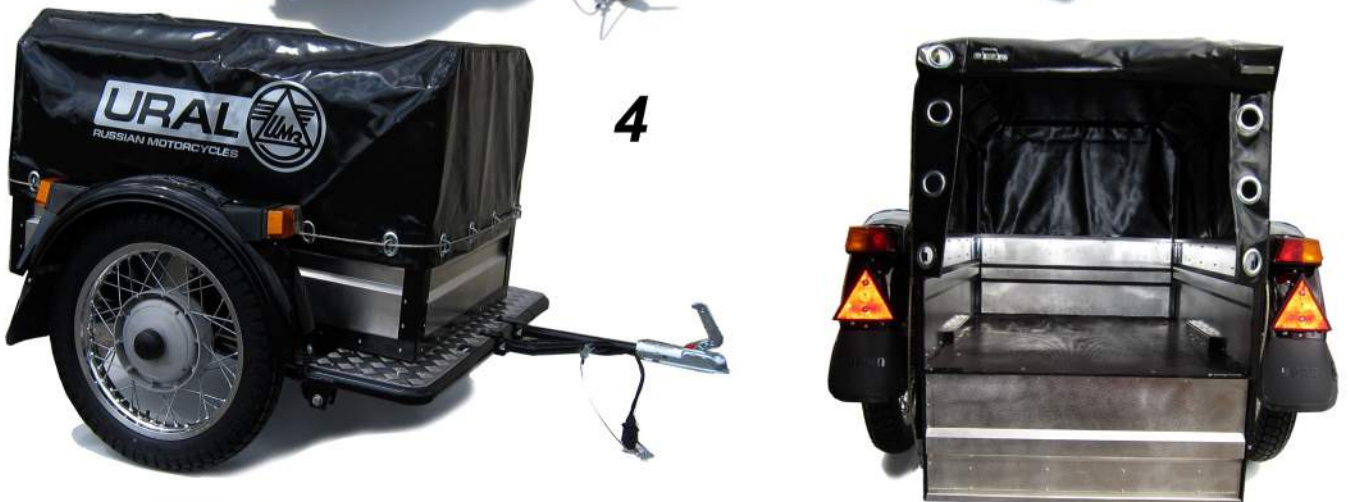
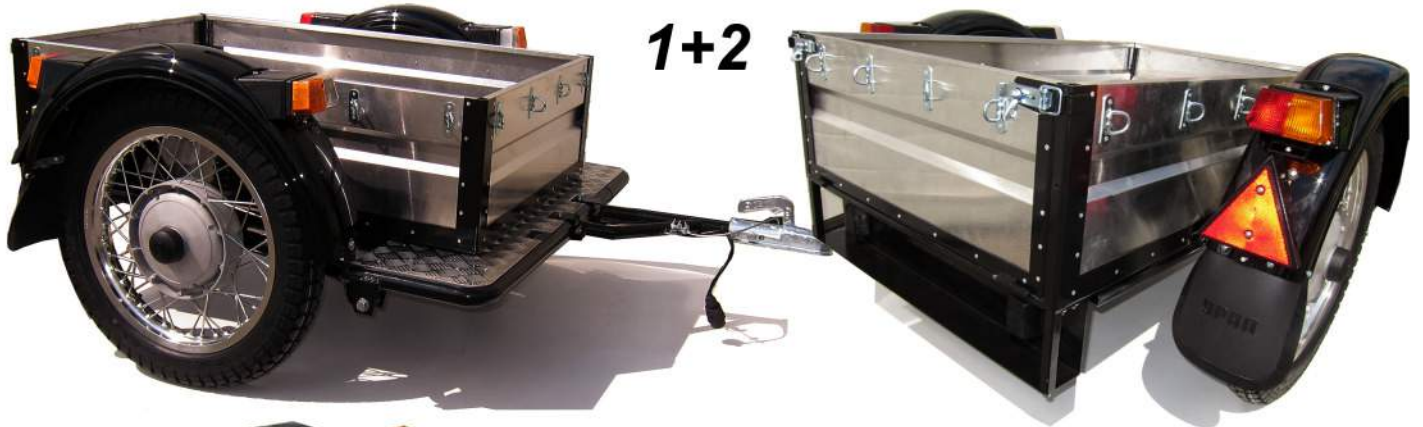



**Fig. Z15.01 Cross sidecar kit**



# Fig. Z16.01 Service parts



1



2

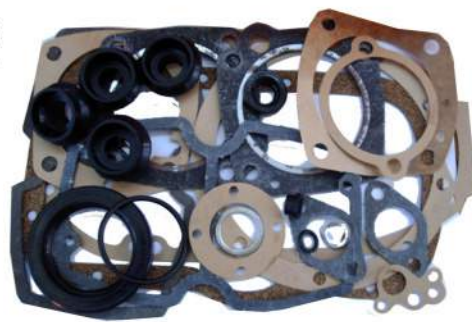

3

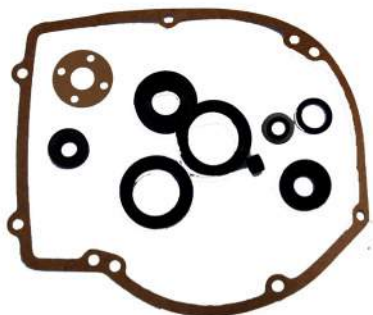

4



5

